UGN.3 / UGN.6



INFO
MORE LANGUAGES

www.varonaleds.com/arq_catalogue/UGN3&UGN6.pdf







DESCRIPTION

VARONALEDS UGN series include different size and power underground projectors. Their ergonomic design and their high IP rating make them suitable for gardens, parks, squares or pedestrian streets.

MATERIALS

Stainless steel top cover
Tempered glass cover
High density plastic embedded base

TECHNICAL

	CREE XP-G2 LEDs		24Vdc
	IP65		1W@350mA
	-35°C/50°C		576lm



REFERENCE

Reference	Series	Voltage	Power	Color	Control	LED Qty.	Lumens
VL-4020-C-OP	UGN.3	24 Vdc	3 W	C	-	3 pcs	288 lm
VL-4021-C-OP	UGN.6	24 Vdc	6 W	C	-	6 pcs	576 lm
VL-4022-RGB-OP	UGN.6	24 Vdc	6 W	RGB	DMX512	6 pcs	423 lm

DIMENSIONS

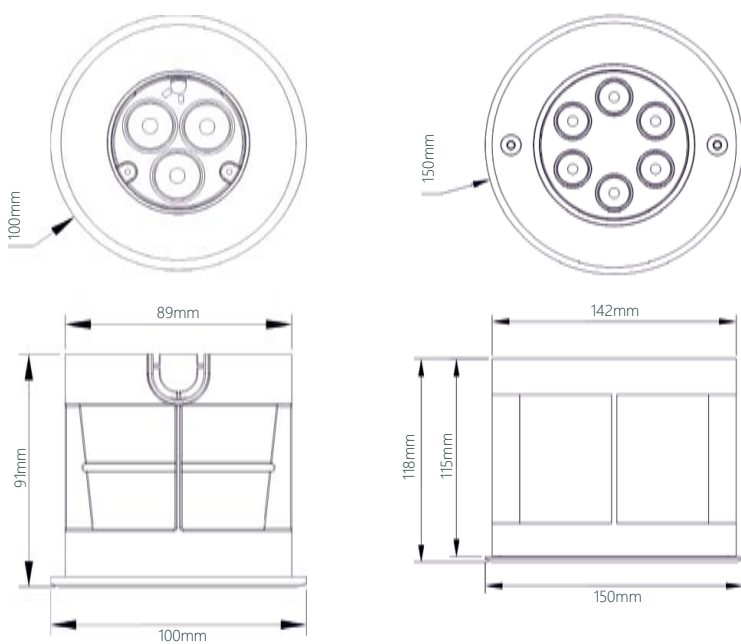

COLORS

■	Code: R 750nm
■	Code: G 750nm
■	Code: B 750nm
■	Code: Y 750nm
<hr/>	
■	Code: WW 3000K
■	Code: NW 4500K
	Code: CW 6000K
<hr/>	
■ ■ ■	Code: RGB DMX512

OPTICS

