NEOSPOT.L36



INFO
MORE LANGUAGES

www.varonaleads.com/arq_catalogue/NEOSPOTL36.pdf







DESCRIPTION

NEOSPOT is a series of high performance round projectors with an ergonomic shape and a patented heat dissipation system. NEOSPOT projectors have a high luminous performance and a outstanding efficient design.

MATERIALS

Heavy duty aluminum alloy body
Tempered glass cover
Akzo Nobel powder coating

TECHNICAL









	CREE XP-G2 LEDs		230Vac/24Vdc
	IP65		2W@550mA
	-35°C/50°C		6192lm



REFERENCE

Reference	Series	Voltage	Power	Color	LED Qty.	Lumens
VL-2064-C-OP	NEOSPOT.L36	230 Vac	72 W	C	36 pcs	6192 lm
VL-2065-RGB-OP	NEOSPOT.L36	230 Vac	72 W	RGB	36 pcs	3636 lm

COLORS

	Code: R 750nm
	Code: G 750nm
	Code: B 750nm
	Code: Y 750nm
<hr/>	
	Code: WW 3000K
	Code: NW 4500K
	Code: CW 6000K
<hr/>	
	Code: RGB DMX512

DIMENSIONS

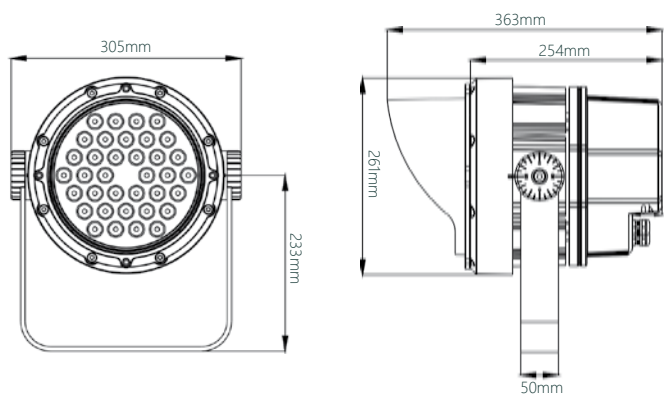

OPTICS

