

---

## UGO.9 / UGO.12

---



INFO  
MORE LANGUAGES

[www.varonaleds.com/arq\\_catalogue/UGO9&UGO12.pdf](http://www.varonaleds.com/arq_catalogue/UGO9&UGO12.pdf)







### DESCRIPTION

VARONALEDS UGO series include different size and power orientable underground projectors. Orientation is made with a remote control to ease orientation after installation. Their ergonomic design and their high IP rating make them suitable for gardens, parks, squares or pedestrian streets.

### MATERIALS

Stainless steel top cover  
Tempered glass cover  
High density plastic embedded base

### TECHNICAL









	CREE XP-G2 LEDs		230Vac/24Vdc
	IP67		3W@700mA
	-35°C/50°C		3456lm



## REFERENCE

Reference	Series	Voltage	Power	Color	Control	LED Qty.	Lumens
VL-4050-C-OP	UGO.9	230 Vac	22 W	C	-	9 pcs	936 lm
VL-4051-RGB-OP	UGO.9	24 Vdc	21 W	RGB	DMX512	9 pcs	470 lm
VL-4052-C-OP	UGO.12	230 Vac	30 W	C	-	12 pcs	1265 lm
VL-4053-RGB-OP	UGO.12	24 Vdc	28 W	RGB	DMX512	12 pcs	626 lm

## COLORS

	Code: R 750nm
	Code: G 750nm
	Code: B 750nm
	Code: Y 750nm
<hr/>	
	Code: WW 3000K
	Code: NW 4500K
	Code: CW 6000K
<hr/>	
	Code: RGB DMX512

## DIMENSIONS

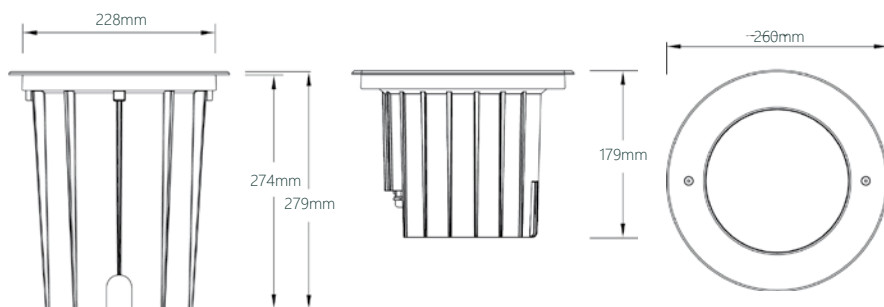

## OPTICS

