NEOSPOT.L72



INFO
MORE LANGUAGES

www.varonaleads.com/arq_catalogue/NEOSPOT.L72.pdf







DESCRIPTION

NEOSPOT is a series of high performance round projectors with an ergonomic shape and a patented heat dissipation system. NEOSPOT projectors have a high luminous performance and a outstanding efficient design.

MATERIALS

Heavy duty aluminum alloy body
Tempered glass cover
Akzo Nobel powder coating

TECHNICAL

	CREE XP-G2 LEDs		230Vac/24Vdc
	IP65		2W@550mA
	-35°C/50°C		12384lm

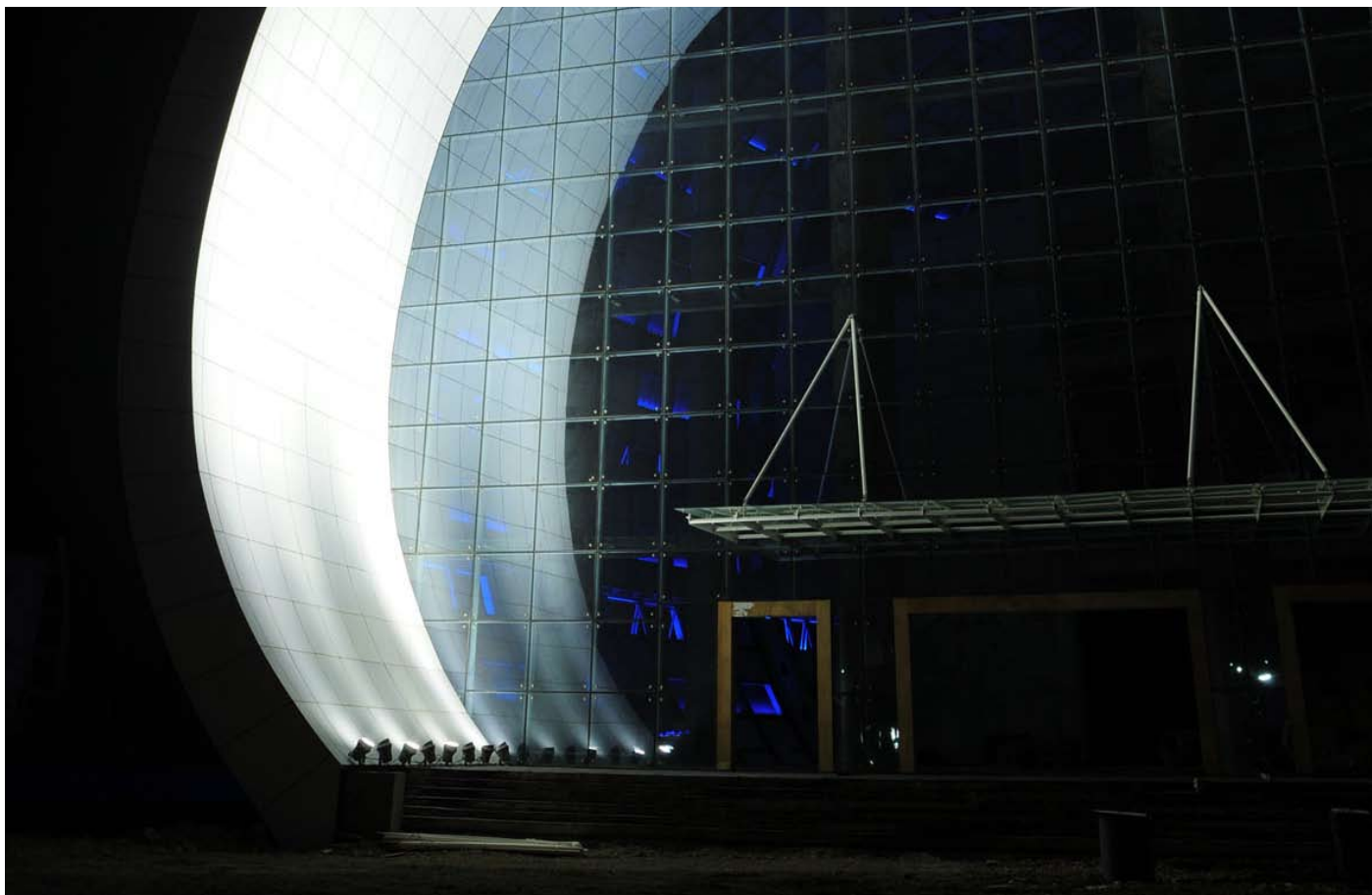

REFERENCE

Reference	Series	Voltage	Power	Color	LED Qty.	Lumens
VL-2066-C-OP	NEOSPOT.L72	230 Vac	144 W	C	72 pcs	12384 lm
VL-2067-RGB-OP	NEOSPOT.L72	230 Vac	144 W	RGB	72 pcs	7272 lm

DIMENSIONS

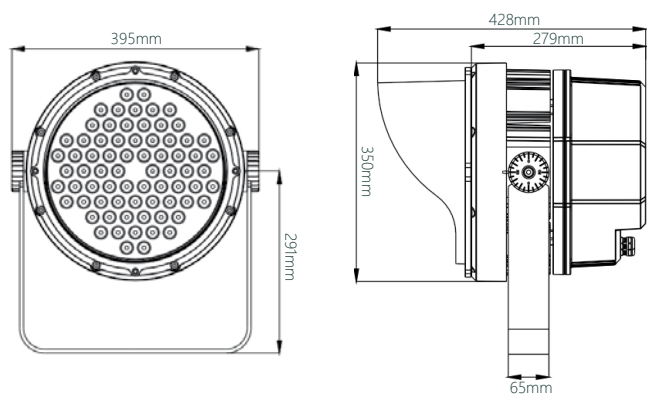

OPTICS

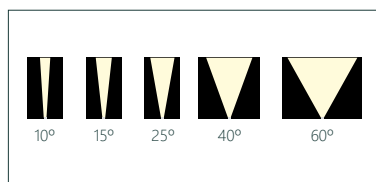

COLORS

■	Code: R 750nm
■	Code: G 750nm
■	Code: B 750nm
■	Code: Y 750nm
<hr/>	
■	Code: WW 3000K
■	Code: NW 4500K
	Code: CW 6000K
<hr/>	
■ ■ ■	Code: RGB DMX512