UNDERLINE.N



INFO
MORE LANGUAGES

www.varonaleads.com/arq_catalogue/UNDERLINEN.pdf







DESCRIPTION

UNDERLINE.N is an underground liner with a robust design. The humanized design is suitable for various applications and the cover design is sufficient for heat radiation, safety and good protection.

MATERIALS

Stainless steel top cover
Tempered glass cover
High density plastic embedded base

TECHNICAL

	CREE XP-G2 LEDs		230Vac/24Vdc
	IP67		2W@500mA
	-35°C/50°C		2696lm









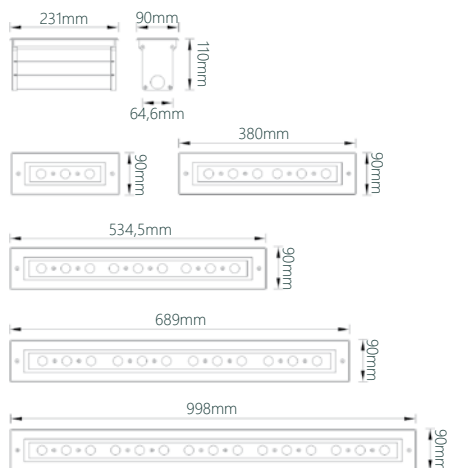

REFERENCE

Reference	Series	Voltage	Power	Color	Control	LED Qty.	Lumens
VL-4210-C-30x65	UNDERLINE.N	230 Vac	9 W	C	-	3 pcs	445 lm
VL-4211-RGB-30x65	UNDERLINE.N	24 Vdc	9 W	RGB	DMX512	3 pcs	139 lm
VL-4212-C-30x65	UNDERLINE.N	230 Vac	17 W	C	-	6 pcs	947 lm
VL-4213-RGB-30x65	UNDERLINE.N	24 Vdc	15 W	RGB	DMX512	6 pcs	422 lm
VL-4214-C-30x65	UNDERLINE.N	230 Vac	25 W	C	-	9 pcs	1432 lm
VL-4215-RGB-30x65	UNDERLINE.N	24 Vdc	23 W	RGB	DMX512	9 pcs	677 lm
VL-4216-C-30x65	UNDERLINE.N	230 Vac	32 W	C	-	12 pcs	1790 lm
VL-4217-RGB-30x65	UNDERLINE.N	24 Vdc	30 W	RGB	DMX512	12 pcs	890 lm
VL-4218-C-30x65	UNDERLINE.N	230 Vac	46 W	C	-	18 pcs	2696 lm
VL-4219-RGB-30x65	UNDERLINE.N	24 Vdc	45 W	RGB	DMX512	18 pcs	1330 lm

DIMENSIONS



COLORS

	Code: R 750nm
	Code: G 750nm
	Code: B 750nm
	Code: Y 750nm
<hr/>	
	Code: WW 3000K
	Code: NW 4500K
	Code: CW 6000K
<hr/>	
	Code: RGB DMX512

OPTICS

