

SMD.UBAR1



INFO
MORE LANGUAGES

www.varonaleads.com/arq_catalogue/SMDUBAR1.pdf







DESCRIPTION

SMD.UBAR is a recessed square transparent SMD bar with acrylic cover to ensure uniform CCT of light source. It also has an excellent waterproof performance.

MATERIALS

Anti UV acrylic cover
Aluminum body
Polyester coating

TECHNICAL

	CREE SMD LEDs		24Vdc
	IP66		SMD 0.3W
	-35°C/50°C		1200lm

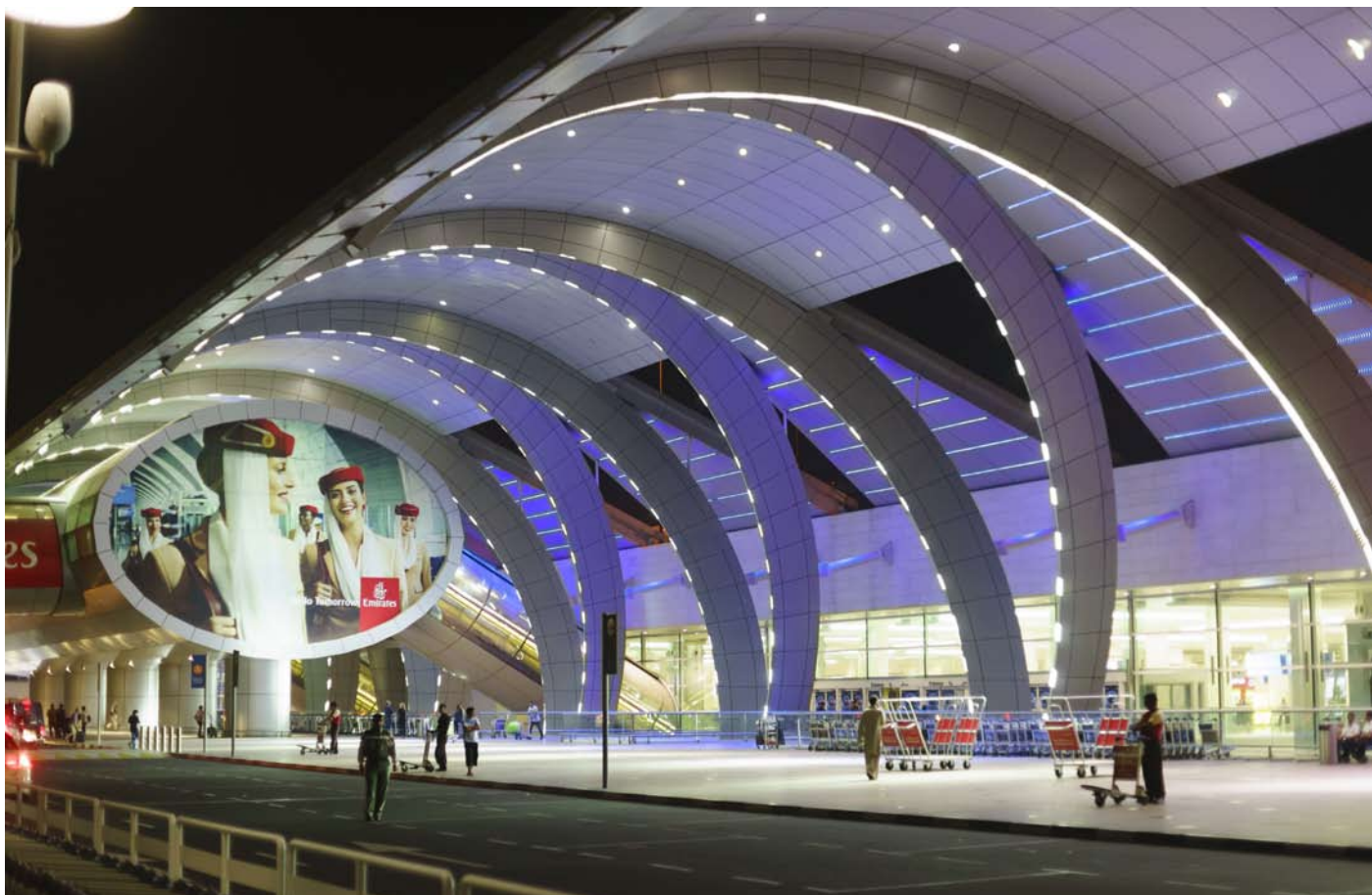

REFERENCE

Reference	Series	Voltage	Power	Color	Control	LED Qty.
VL-6020-C	SMD.UBAR1	24 Vdc	11 W	C	-	48 pcs
VL-6021-RGB	SMD.UBAR1	24 Vdc	11 W	RGB	DMX512	48 pcs



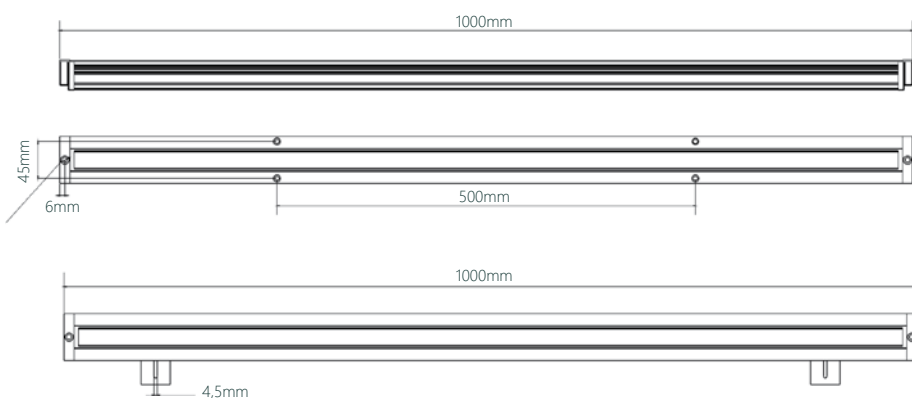



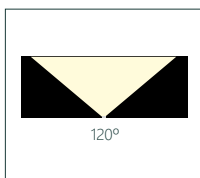

DIMENSIONS



OPTICS



COLORS

	Code: R 750nm
	Code: G 750nm
	Code: B 750nm
	Code: Y 750nm
<hr/>	
	Code: WW 3000K
	Code: NW 4500K
	Code: CW 6000K
<hr/>	
	Code: RGB DMX512