NEOSPOT.L18



INFO
MORE LANGUAGES

www.varonaleads.com/arg_catalogue/NEOSPOTL18.pdf







DESCRIPTION

NEOSPOT is a series of high performance round projectors with an ergonomic shape and a patented heat dissipation system. NEOSPOT projectors have a high luminous performance and a outstanding efficient design.

MATERIALS

Heavy duty aluminum alloy body
Tempered glass cover
Akzo Nobel powder coating

TECHNICAL

	CREE XP-G2 LEDs		230Vac/24Vdc
	IP65		2W@550mA
	-35°C/50°C		3096lm

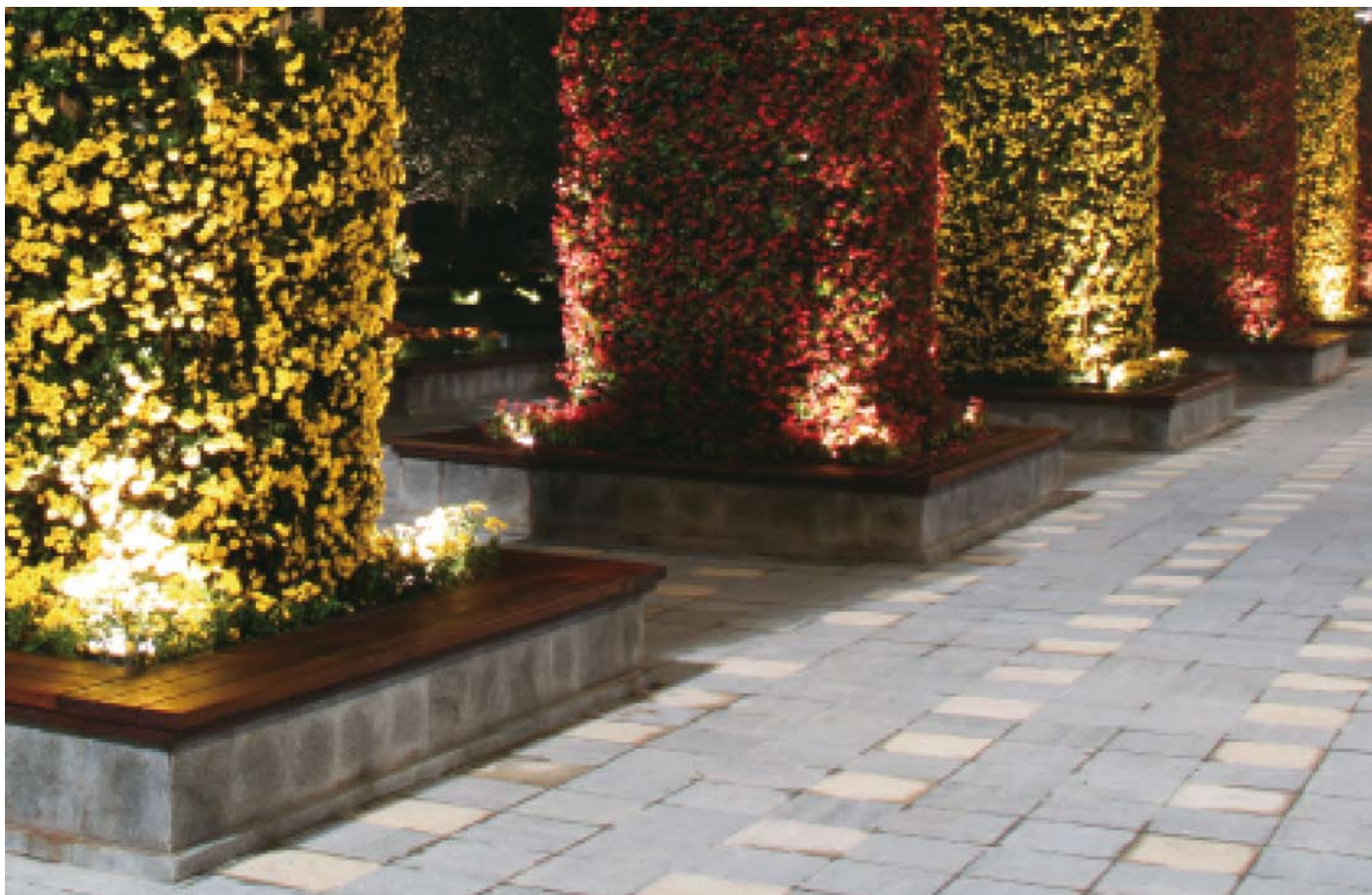

REFERENCE

Reference	Series	Voltage	Power	Color	LED Qty.	Lumens
VL-2062-C-OP	NEOSPOT.L18	230 Vac	36 W	C	18 pcs	3096 lm
VL-2063-RGB-OP	NEOSPOT.L18	230 Vac	36 W	RGB	18 pcs	1818 lm

DIMENSIONS

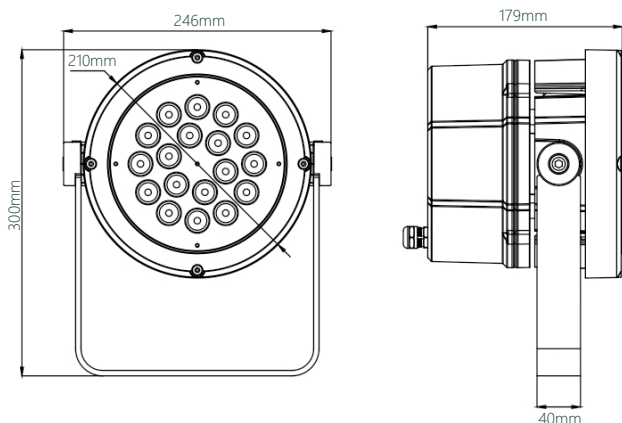

OPTICS

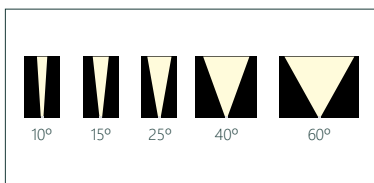

COLORS

■	Code: R 750nm
■	Code: G 750nm
■	Code: B 750nm
■	Code: Y 750nm
<hr/>	
■	Code: WW 3000K
■	Code: NW 4500K
	Code: CW 6000K
<hr/>	
■ ■ ■	Code: RGB DMX512
■ ■ ■ ■	Code: RGB - WW DMX512
■ ■ ■ 	Code: RGB - W DMX512