SQ.KAPIK.18



INFO
MORE LANGUAGES

www.varonaleds.com/arq_catalogue/SQKAPIK18.pdf







DESCRIPTION

SQ.KAPIK series are high performance rectangular projectors with an ergonomic shape and a patented heat dissipation system. SQ.KAPIK have a high luminous performance in a very reduce size.

MATERIALS

Heavy duty aluminum alloy body
Tempered glass cover
Akzo Nobel powder coating

TECHNICAL

	CREE XP-G2 LEDs		230Vac
	IP65		2W@550mA
	-35°C/50°C		2330lm

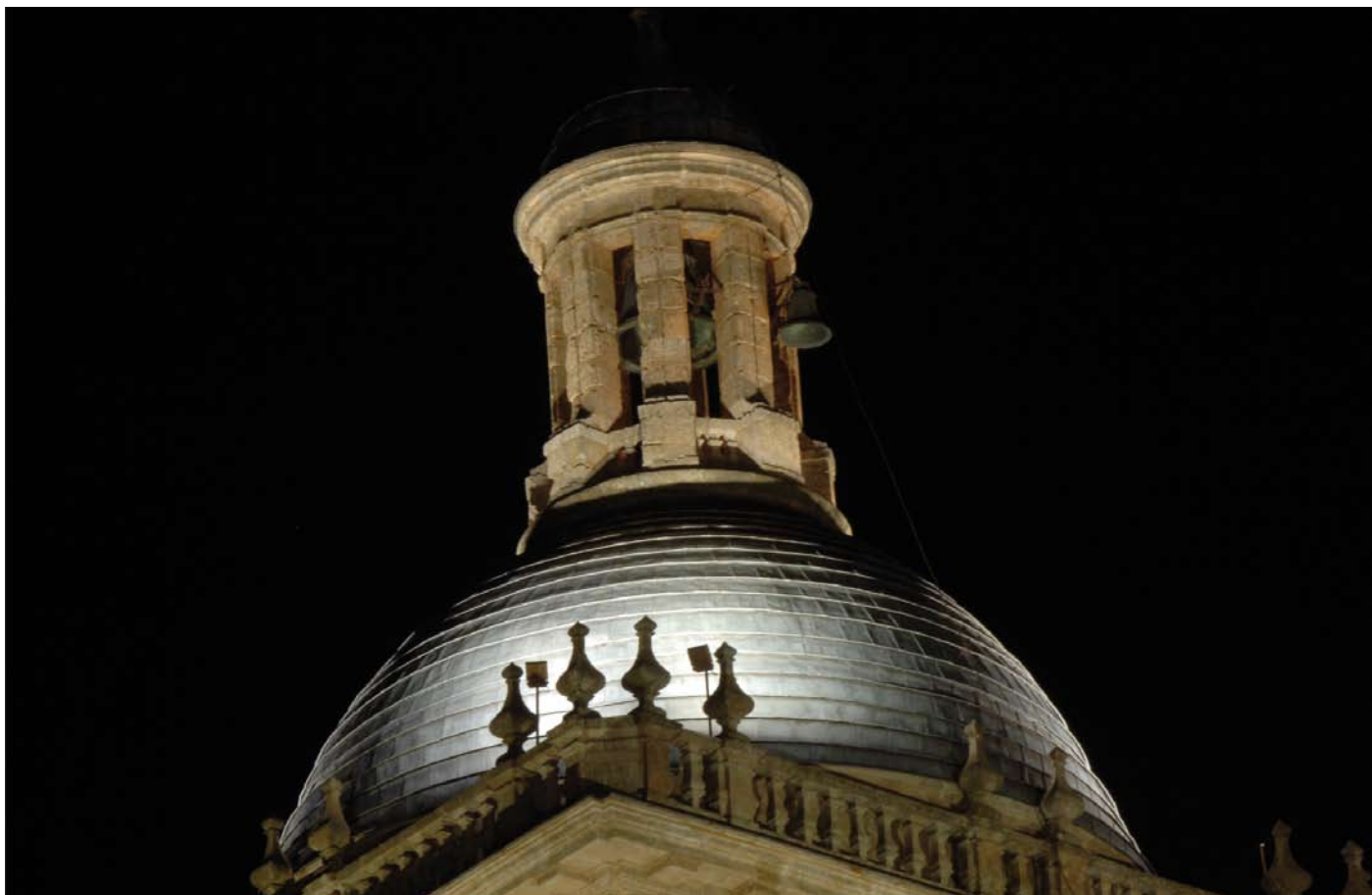

REFERENCE

Reference	Series	Voltage	Power	Color	LED Qty.	Lumens
VL-2110-C-OP	SQ,KAPIK.18	230 Vac	36 W	C	18 pcs	2330 lm
VL-2111-RGB-OP	SQ,KAPIK.18	230 Vac	45 W	RGB	18 pcs	1150 lm

DIMENSIONS

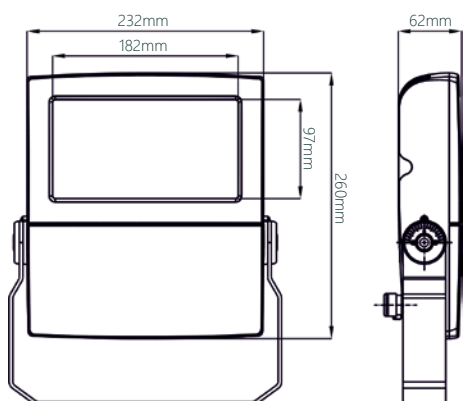

COLORS

■	Code: R 750nm
■	Code: G 750nm
■	Code: B 750nm
■	Code: Y 750nm
<hr/>	
■	Code: WW 3000K
■	Code: NW 4500K
	Code: CW 6000K
<hr/>	
■ ■ ■	Code: RGB DMX512

OPTICS

