

---

## NEOSPOT.L9

---



INFO  
MORE LANGUAGES

[www.varonaleds.com/arq\\_catalogue/NEOSPOT.L9.pdf](http://www.varonaleds.com/arq_catalogue/NEOSPOT.L9.pdf)







### DESCRIPTION

NEOSPOT is a series of high performance round projectors with an ergonomic shape and a patented heat dissipation system. NEOSPOT projectors have a high luminous performance and a outstanding efficient design.

### MATERIALS

Heavy duty aluminum alloy body  
Tempered glass cover  
Akzo Nobel powder coating

### TECHNICAL

	CREE XP-G2 LEDs		230Vac/24Vdc
	IP65		2W@550mA
	-35°C/50°C		1530lm



## REFERENCE

Reference	Series	Voltage	Power	Color	LED Qty.	Lumens
VL-2060-C-OP	NEOSPOTL9	230 Vac	18 W	C	9 pcs	1548 lm
VL-2061-RGB-OP	NEOSPOTL9	24 Vdc	24 W	RGB	12 pcs	1212 lm

## DIMENSIONS

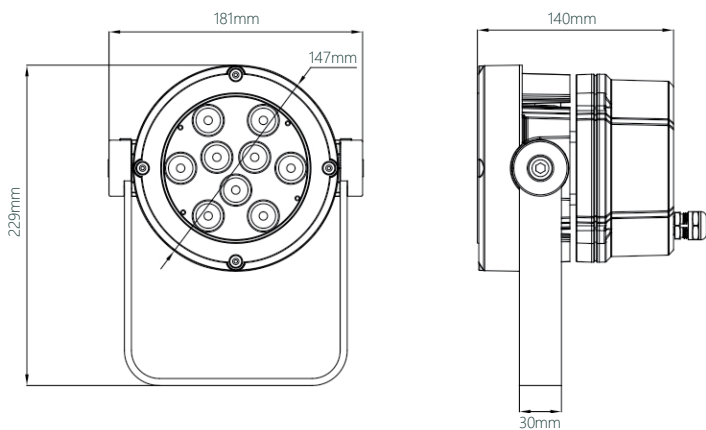

## OPTICS

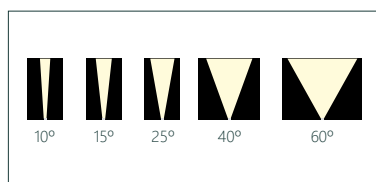

## COLORS

<span style="color: red;">■</span>	Code: R 750nm
<span style="color: green;">■</span>	Code: G 750nm
<span style="color: blue;">■</span>	Code: B 750nm
<span style="color: yellow;">■</span>	Code: Y 750nm
<hr/>	
<span style="color: yellow;">■</span>	Code: WW 3000K
<span style="color: lightyellow;">■</span>	Code: NW 4500K
<span style="border: 1px solid black; display: inline-block; width: 10px; height: 10px;"></span>	Code: CW 6000K
<hr/>	
<span style="color: red;">■</span> <span style="color: green;">■</span> <span style="color: blue;">■</span>	Code: RGB DMX512
<span style="color: red;">■</span> <span style="color: green;">■</span> <span style="color: blue;">■</span> <span style="color: yellow;">■</span>	Code: RGB - WW DMX512
<span style="color: red;">■</span> <span style="color: green;">■</span> <span style="color: blue;">■</span> <span style="color: white;">■</span>	Code: RGB - W DMX512