POINT.3



INFO
MORE LANGUAGES
www.varonaleds.com/arq_catalogue/POINT3.pdf







DESCRIPTION

POINT is a point lamp to create decorative effects. Available with different PMMA covers and different powers. Its main applications are landscape, buildings, bridge or shopping mall lighting.

MATERIALS

Aluminum alloy housing
Tempered glass
Akzo Nobel powder coating

TECHNICAL









| | | | |
|---|---------------|---|----------|
|  | CREE SMD LEDs |  | 24Vdc |
|  | IP66 |  | SMD 0.3W |
|  | -35°C/50°C |  | 360lm |



REFERENCE

| Reference | Series | Voltage | Power | Color | Control | LED Qty. | Diffuser type |
|---------------|---------|---------|-------|-------|---------|----------|---------------|
| VL-9000-C-A | POINT.3 | 24 Vdc | 2,9 W | C | - | 12 pcs | A |
| VL-9001-RGB-A | POINT.3 | 24 Vdc | 3,2 W | RGB | DMX512 | 12 pcs | A |
| VL-9002-C-B | POINT.3 | 24 Vdc | 2,9 W | C | - | 12 pcs | B |
| VL-9003-RGB-B | POINT.3 | 24 Vdc | 3,2 W | RGB | DMX512 | 12 pcs | B |
| VL-9004-C-C | POINT.3 | 24 Vdc | 2,9 W | C | - | 12 pcs | C |
| VL-9005-RGB-C | POINT.3 | 24 Vdc | 3,2 W | RGB | DMX512 | 12 pcs | C |

COLORS

| | |
|---|---------------------|
|  | Code: R 750nm |
|  | Code: G 750nm |
|  | Code: B 750nm |
|  | Code: Y 750nm |
| <hr/> | |
|  | Code: WW 3000K |
|  | Code: NW 4500K |
|  | Code: CW 6000K |
| <hr/> | |
|  | Code: RGB DMX512 |

DIMENSIONS

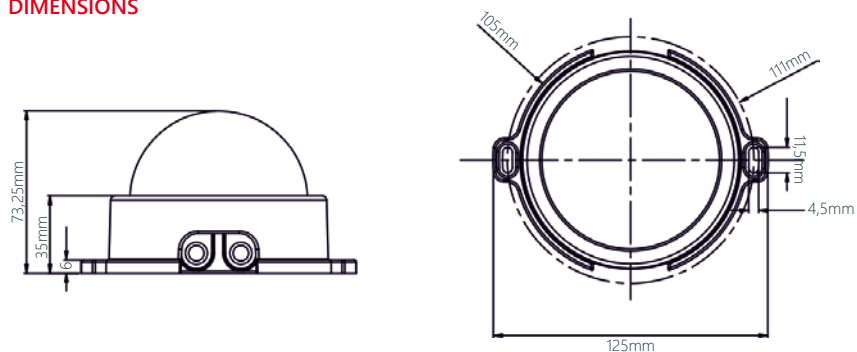

OPTICS

