SQ.KAPIK.36



INFO
MORE LANGUAGES

www.varonaleds.com/arq_catalogue/SQKAPIK36.pdf







DESCRIPTION

SQ.KAPIK series are high performance rectangular projectors with an ergonomic shape and a patented heat dissipation system. SQ.KAPIK have a high luminous performance in a very reduce size.

MATERIALS

Heavy duty aluminum alloy body
Tempered glass cover
Akzo Nobel powder coating

TECHNICAL

	CREE XP-G2 LEDs		230Vac
	IP65		3W@700mA
	-35°C/50°C		4159lm



REFERENCE

Reference	Series	Voltage	Power	Color	LED Qty.	Lumens
VL-2112-C-OP	SQ,KAPIK.36	230 Vac	80 W	C	36 pcs	4159 lm
VL-2113-RGB-OP	SQ,KAPIK.36	230 Vac	90 W	RGB	36 pcs	2648 lm
VL-2114-RGBW-OP	SQ,KAPIK.36	230 Vac	90 W	RGBW	36 pcs	2454 lm



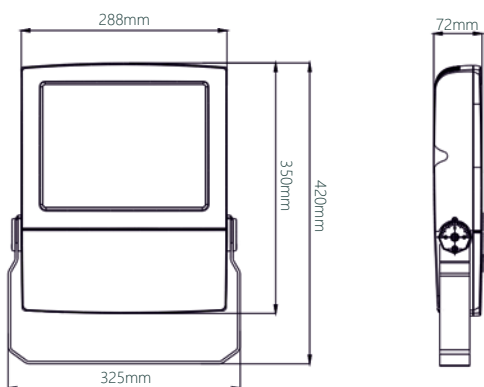



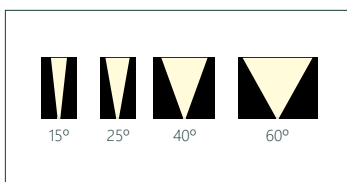



DIMENSIONS



OPTICS



COLORS

	Code: R 750nm
	Code: G 750nm
	Code: B 750nm
	Code: Y 750nm
<hr/>	
	Code: WW 3000K
	Code: NW 4500K
	Code: CW 6000K
<hr/>	
	Code: RGB DMX512
	Code: RGB - WW DMX512
	Code: RGB - W DMX512