

---

## AQUA.UG3

---



INFO  
MORE LANGUAGES

[www.varonaleds.com/arq\\_catalogue/AQUAUG3.pdf](http://www.varonaleds.com/arq_catalogue/AQUAUG3.pdf)







### DESCRIPTION

AQUA series are underwater projectors, recessed and surface mounted, completely built in stainless steel. The wide variety of optics and the RGBW 4in1 colour changing LEDs allow to create any light effect in swimming pools and fountains.

### MATERIALS

316 stainless steel housing  
Tempered glass  
Surface polishing

### TECHNICAL

	CREE XP-G2 XM-E LEDs		12Vdc
	IP68		1W@350mA 4in1 4W
	-35°C/50°C		300lm



## REFERENCE

Reference	Series	Voltage	Power	LED Qty.	Lumens
VL-8010-C-OP	AQUA.UG3	12 Vdc	3,0 W	3 pcs	300 lm
VL-8011-RGBW-OP	AQUA.UG3	12 Vdc	4 W	1 pcs	224 lm

## DIMENSIONS

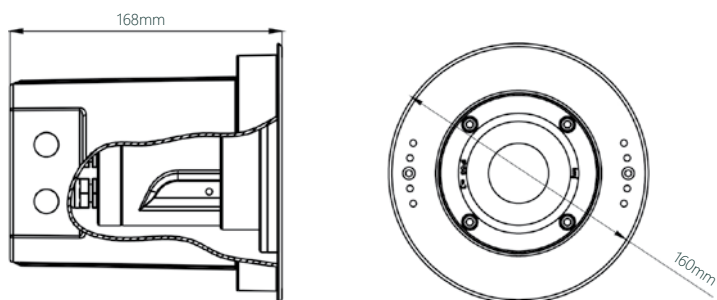

## OPTICS

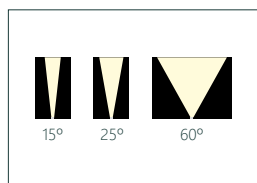

## COLORS

<span style="color: red;">■</span>	Code: R 750nm
<span style="color: green;">■</span>	Code: G 750nm
<span style="color: blue;">■</span>	Code: B 750nm
<span style="color: yellow;">■</span>	Code: Y 750nm
<hr/>	
<span style="color: yellow;">■</span>	Code: WW 3000K
<span style="color: lightyellow;">■</span>	Code: NW 4500K
<span style="border: 1px solid black; display: inline-block; width: 10px; height: 10px;"></span>	Code: CW 6000K
<hr/>	
<span style="color: red;">■</span> <span style="color: green;">■</span> <span style="color: blue;">■</span>	Code: RGB DMX512