UGO.18 / UGO.24



INFO
MORE LANGUAGES

www.varonaleads.com/arq_catalogue/UGO18&UGO24.pdf







DESCRIPTION

VARONALEDS UGO series include different size and power orientable underground projectors. Orientation is made with a remote control to ease orientation after installation. Their ergonomic design and their high IP rating make them suitable for gardens, parks, squares or pedestrian streets.

MATERIALS

Stainless steel top cover
Tempered glass cover
High density plastic embedded base

TECHNICAL









	CREE XP-G2 LEDs		230Vac/24Vdc
	IP67		3W@700mA
	-35°C/50°C		246lm



REFERENCE

Reference	Series	Voltage	Power	Color	Control	LED Qty.	Lumens
VL-4054-C-OP	UGO.18	230 Vac	43 W	C	-	18 pcs	1789 lm
VL-4055-RGB-OP	UGO.18	24 Vdc	40 W	RGB	DMX512	18 pcs	890 lm
VL-4056-C-OP	UGO.24	230 Vac	57 W	C	-	24 pcs	2461 lm
VL-4057-RGB-OP	UGO.24	24 Vdc	53 W	RGB	DMX512	24 pcs	1285 lm

COLORS

	Code: R 750nm
	Code: G 750nm
	Code: B 750nm
	Code: Y 750nm
<hr/>	
	Code: WW 3000K
	Code: NW 4500K
	Code: CW 6000K
<hr/>	
	Code: RGB DMX512

DIMENSIONS

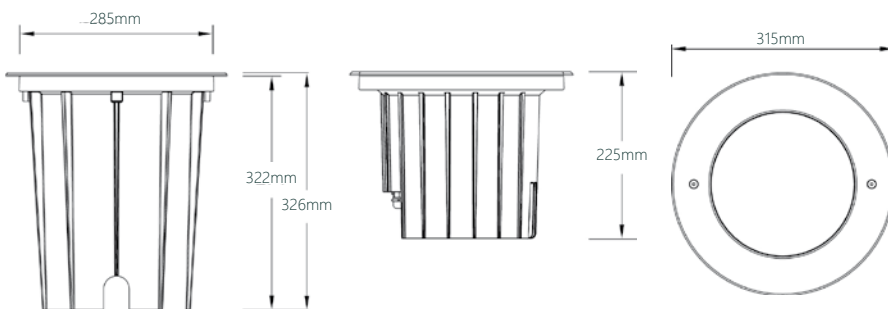

OPTICS

